

IK1523

The IK1523 camera is a highly sensitive infrared camera (SWIR, NIR). The sensitivity interval reaches from 900 nm to 1700 nm. A sophisticated, thermal optimized housing allows sensor operation without active cooling. The optional available M42 to C-mount adapter extends the number of lenses which can be used with this camera. Via standard USB2.0 interface can be controlled by each PC or notebook. The 14-bit A/D converter provides high dynamics of captured image data. Correction procedures specially adapted to properties of InGaAs sensors assure very high image quality. In order to increase sensitivity and to extent reasonable exposure time there is the optional possibility to cool down the sensor to $< -20^{\circ}\text{C}$.

Sensor Properties

- InGaAs
- 640×512 pixel
- $25 \mu\text{m} \times 25 \mu\text{m}$ pixel size
- built-in thermo-electric cooler (TEC)
- percentage of good pixels $> 99,5 \%$
- quantum efficiency $> 70 \%$
- progressive scan
- global shutter



Application Examples

- laser beam profiling
- NIR (SWIR) – image processing
- spatially resolved NIR spectroscopy
- imaging improvement, (undercover) surveillance
- quality insurance in semiconductor industry, e.g. solar cell inspection
- scientific applications (medicine [e.g. OCT], biology, astronomy)
- material analysis (plastics, textiles, glass, metal, wood)
- industrial thermal image processing for temperatures $> 200^{\circ}\text{C}$
- process surveillance
- 2D humidity analysis, water detection
- biometry (artificial hair appears black and natural hair white)
- analysis of paintings (art history, falsification detection)

Spectral Sensor Sensitivity

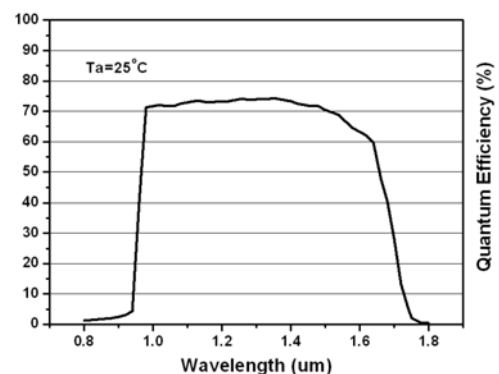

Technical Specifications

Sensor	InGaAs matrix sensor
Resolution	640 (H) × 512 (V)
Pixel size	25 × 25 μm ²
Spectral range	0.9 μm – 1.7 μm
Active Sensor size	16 mm (H) × 12.8 mm (V)
A/D resolution	14 bit
Frame rate	30 fps
Exposure time	10 μs - 3 s
Gain	Two modes (low gain and high gain) Gain factor: 27
Digital interface	USB2.0 (HighSpeed)
Trigger	opto-decoupled
Power supply	12-24 V (DC)
Power loss	< 5 W (without cooling)
Sensor cooling	TEC
Temperature range (operational)	0 °C - + 55 °C
Temperature range (store)	- 40 °C - + 55 °C
Housing	anodized aluminum with integrated cooling fins
Dimensions without lens	73.5 × 91 × 91 mm ³
Weight (without lens)	ca. 1300 g
Lens mount	M42 or C – Mount; adjustable

Frontal View

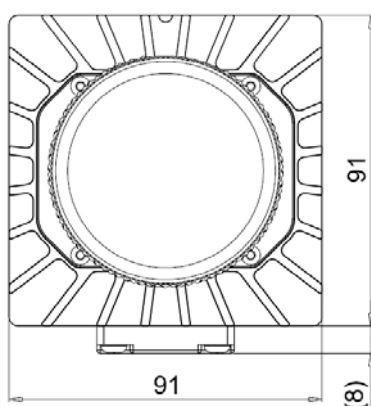

Lateral View

